



LABORATORY LINES

REFRIGERATORS AND
FREEZERS



Kalstein®

A different accompaniment, at your service

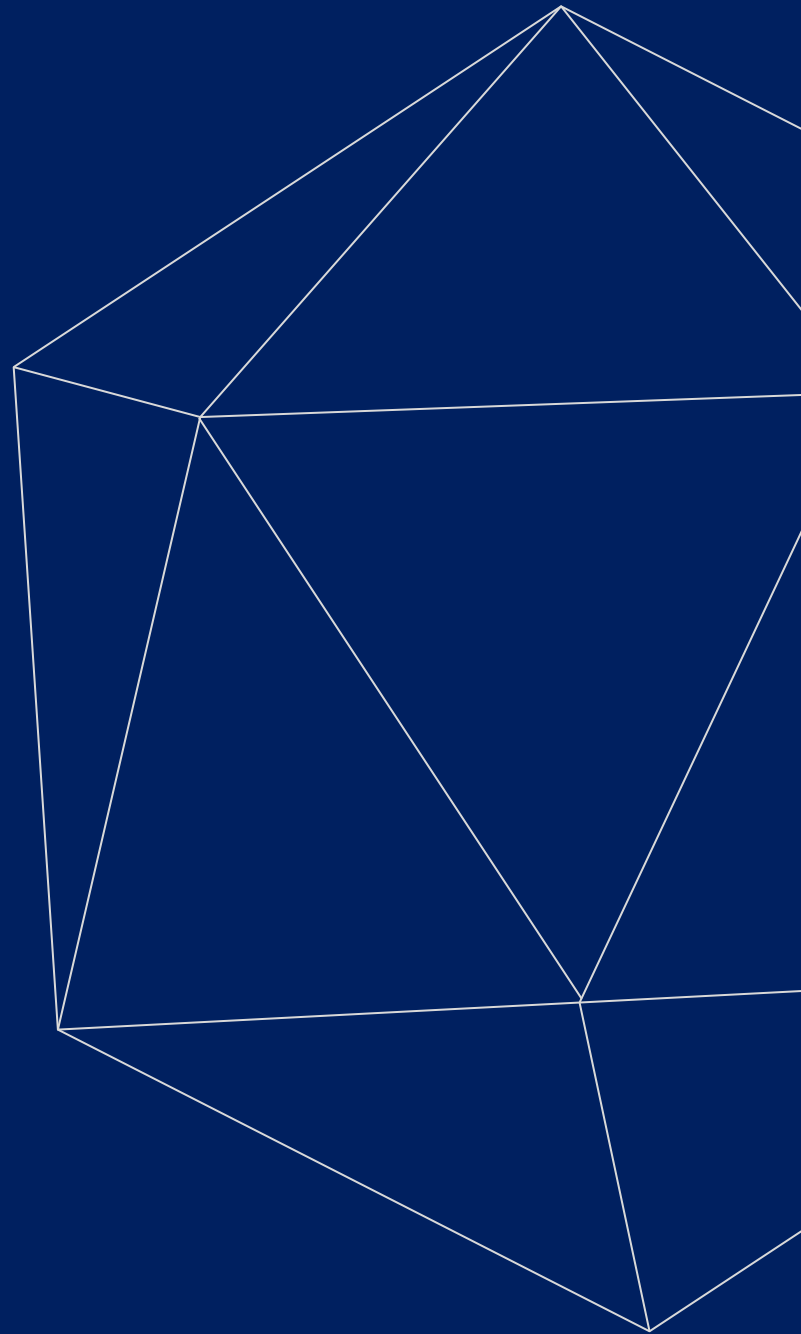



Kalstein®

A different accompaniment, at your service

OUR SERVICES

Benefits and Support

In Kalstein France, we take care of the full satisfaction of our customers, that is why we provide value-added services of the highest level based on our experience.



Online Inductions and Trainings

In any part of the world, receive your induction or training from our specialized team of engineers



Quick Response

Our work team is always available to response all your consults or questions, in order to support you in any situation.



#Letsgivemore ♥

Thanks to your purchase, a donation is made to a non-profit foundation that fights against cancer and helps vulnerable communities.



Technical Support

Enjoy of personalized advice for the correct preventive and corrective maintenance of your equipment, thanks to Kalstein's manuals and articles, special catalogues and video tutorials.



Delivery Logistics

We take care of all the necessary logistics for the dispatch of your goods, whether is by sea, land or air.



Kalstein Worldwide

With more than 25 years growing with our customers, Kalstein's multiformat and modern content, is now present in more than 10 countries and increasing.



-40 °C To -86° Ultra Low Freezer 728L Serie YR5304 (Dual System)



This product is specially designed and manufactured for long term storage of various biological product, including viruses, germs, erythrocytes, leucocytes and cutis. Applications can be found in blood banks, hospitals, epidemic prevention services, and research institutes, laboratories in electronic and chemical plants. Biological engineering institutes and marine fishery companies

Safety

- ✓ Malfunction alarms including high and low temperature, power failure, sensor error, clean-filter, and extremely high ambient, abnormal voltage, thermostat failure, low battery, condenser clean, door ajar.
- ✓ Capable of producing two types of alarm outputs, audible buzzer and visible flashing light .
- ✓ Door open feature standard and USB port for temperature date downloading standard on upright models.
- ✓ Remote alarm contacts.

Installation and Application

- ✓ Wide range operating voltage system from 187V to 242V designed to allow units installed in areas with poor voltage condition.
- ✓ Suitable for 10°C to 32°C ambient temperature.

Filed Proven Reliability

- ✓ Unique insulated inner door design for four separate storage compartments to minimize frost buildup inside the chamber.
- ✓ Specialized control system design for a well-balanced operation of cascade refrigeration system.
- ✓ Positive filed proven reliability record.

Key Design Features

- ✓ Microprocessor-controlled system designed for controlled range of -40°C to -86°C for cabinet space with 1°C increment
- ✓ Settable high temperature and low temperature alarms.
- ✓ Automatic clean-filter alarm and sensor error alert.
- ✓ Adjustable storage shelf height
- ✓ Optional temperature recorder, storage racks and storage box.
- ✓ Double security with two independent cooling system, when one system breakdown, the other system could maintain the inner temperature at -70°C.

Energy saving:

- ✓ Unique door seal design for the minimum loss of cold temperature during a door opening.
- ✓ High performance VIP insulation panel to minimize cabinet heat gain and to improve temperature stability.

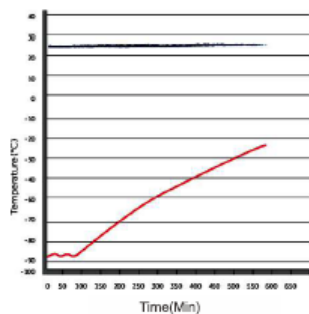

Pull-up test at 25°C ambient

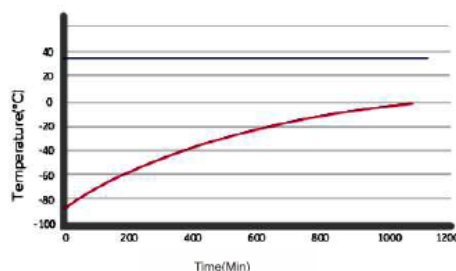

Pull-up test at 32°C ambient



#Let'sgive more

Thanks to your purchase, a donation is made to a non-profit foundation that fights against cancer and helps vulnerable communities.



All rights reserved © KALSTEIN France S. A. S.,
2 Rue Jean Lantier • 75001 Paris •
+33 1 78 95 87 89 / +33 6 80 76 07 10 •
<https://kalstein.eu>
KALSTEIN FRANCE, S. A. S



-40 °C To -86° Ultra Low Freezer 728L Serie YR5304 (Dual System)

 Energy-saving and environmental friendly



2 individual inner doors can be opened independently to minimize frost buildup inside the chamber
Unique door seal design for the minimum loss of cold temperature during a door opening
Stainless Steel handle to ensure the door open conveniently even in the case of frost



Excellent Doors Seals
5 gasket seal, 4 seals for out door



7 Inches touch Screen
All data display on the screen, easy to observe

Write Board for short records which would pass to next user

Green Handle, easy to use with 2 locks

Special V.I.P (Vacuum Insulation Panel) design with extra insulation factor cuts down heat loss to cabinet by 25%



Big condenser for better heat dissipation



Changeable sensor box or you could put another sensor from here to monitor or record temperature



#Letsgivemore ♥

Thanks to your purchase, a donation is made to a non-profit foundation that fights against cancer and helps vulnerable communities.



All rights reserved © KALSTEIN France S. A. S.,
2 Rue Jean Lantier • 75001 Paris •
+33 1 78 95 87 89 / +33 6 80 76 07 10 •
<https://kalstein.eu>
KALSTEIN FRANCE, S. A. S



-40 °C To -86° Ultra Low Freezer 728L
Serie YR5304 (Dual System)

 Energy-saving and environmental friendly



Dual System Circulation System

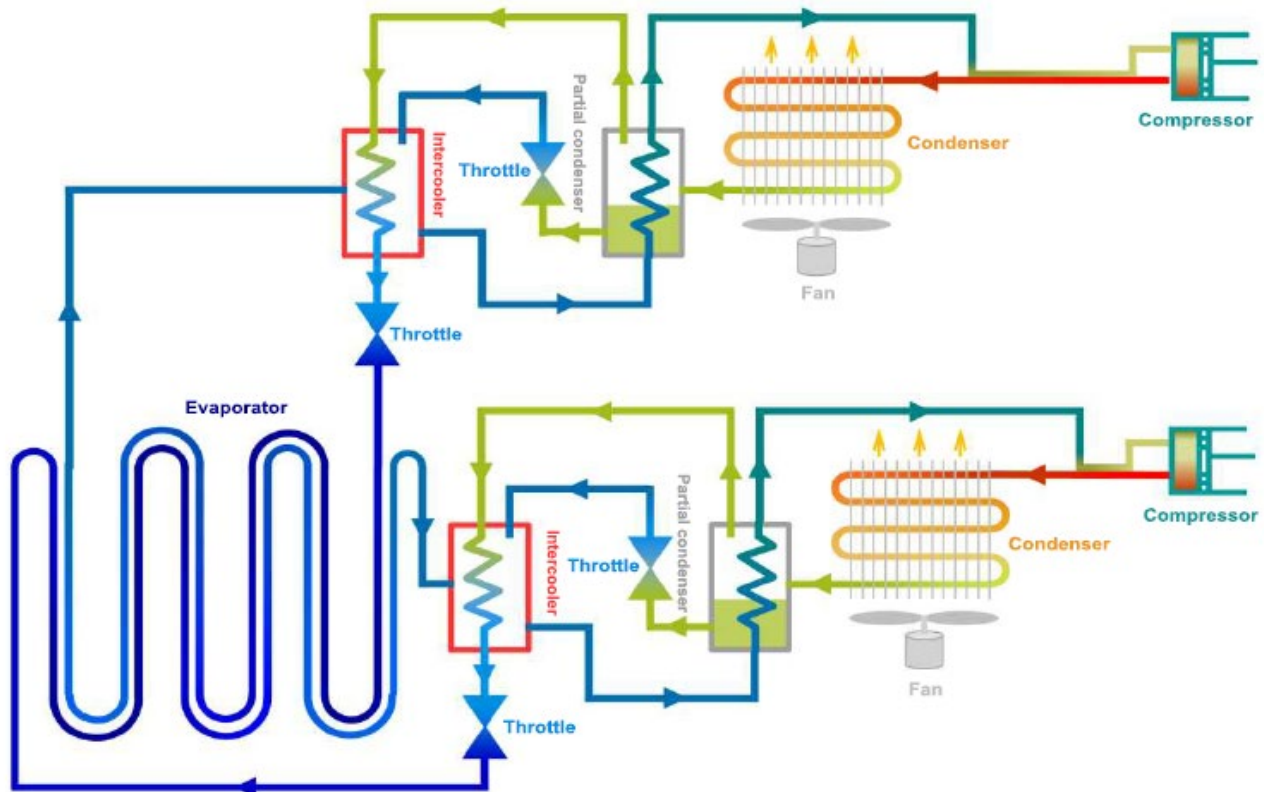

#Let'sgive more ♥
 Thanks to your purchase, a donation is made to a non-profit foundation that fights against cancer and helps vulnerable communities.



All rights reserved © KALSTEIN France S. A. S.,
 2 Rue Jean Lantier • 75001 Paris •
 +33 1 78 95 87 89 / +33 6 80 76 07 10 •
<https://kalstein.eu>
KALSTEIN FRANCE, S. A. S



-40 °C To -86° Ultra Low Freezer 728L Serie YR5304 (Dual System)



7 Inches Touch Screen & Functions

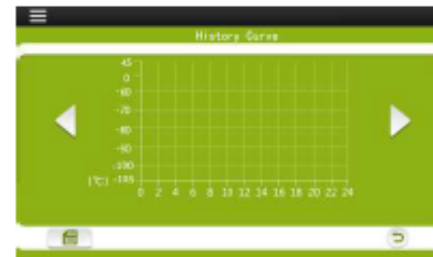
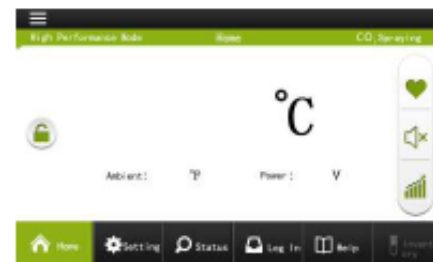

Alarm	Alarm Triggering Condition
High Temperature	Temperature reaches the warm alarm limit
Low Temperature	Temperature reaches the low alarm limit
Power Failure	Equipment loses power
Door Ajar	Door open period exceeds 5 mins
Probe Failure	<ol style="list-style-type: none"> 1. Main cabinet temperature control sensor fails 2. Condenser sensor fails 3. Ambient sensor fails 4. Heat exchanger sensor fails 5. Heat exchanger temperature fails
Low Battery	Battery capacity runs low or battery switch is not turned on
Hot Condenser	<ol style="list-style-type: none"> 1. Condensers filter element is clogged 2. Ambient temperature is too high
High Ambient Temperature	Ambient temperature exceeds 32°C
Other alarms	<ol style="list-style-type: none"> 1. Thermostat failure 2. Abnormal voltage alarm



#Let'sgive more ❤️
Thanks to your purchase, a donation is made to a non-profit foundation that fights against cancer and helps vulnerable communities.



All rights reserved © KALSTEIN France S. A. S.,
2 Rue Jean Lantier • 75001 Paris •
+33 1 78 95 87 89 / +33 6 80 76 07 10 •
<https://kalstein.eu>
KALSTEIN FRANCE, S. A. S



-40 °C To -86° Ultra Low Freezer 728L Serie YR5304 (Dual System)



	Model	YR05302	YR05303	YR05304	YR05405
Specifications	Shelf/drawer QTY	Stainless steel shelf/3	Stainless steel shelf/3	Stainless steel shelf/3	Stainless steel shelf/3
	Cooling	Direct cooling	Direct cooling	Direct cooling	Direct cooling
	Defrost	Manual	Manual	Manual	Manual
	Refrigerant	Mixed-gas	Mixed-gas	Mixed-gas	Mixed-gas
	Power Consumption(kWh/24h)	14.5	16.5		18.8
	Noise (db)	53	53	53	55
	Ambient temperature (°C)	10~32°C	10~32°C	10~32°C	10~32°C
	Temperature range (°C)	-40~-86°C	-40~-86°C	-40~-86°C	-40~-86°C
Cooling system	Compressor brand/QTY	SECOP/2	SECOP/2	SECOP/2	SECOP/2
	Sensor	PTC	PTC	PTC	PTC
	Temperature controller	Microprocessor	Microprocessor	Microprocessor	Microprocessor
	Display	LCD display	LCD display	LCD display	LCD display
Power	Voltage/frequency (V/Hz)	220/50Hz	220/50Hz	220/50Hz	220/50Hz
	Power (W)	1350W	1500W		1700W
	Current (A)	8A	9.1A		9.8A
Material	Inside material	Stainless steel	Stainless steel	Stainless steel	Stainless steel
	Outside material	Color sprayed steel	Color sprayed steel	Color sprayed steel	Color sprayed steel
	Insulation	PURF	PURF	PURF	PURF
Size	Capacity (L/cu.ft)	408	588	728	838
	NT/GT. (kg)	255/307	297.5/358.5	360/401.5	336.5/416
	Exterior size(W*D*H)(mm)	900*940*1940	885*1100*1995	1260*890*2010	1190*1045*2010
	Interior size(W*D*H)(mm)	606*575*1180	606*738*1310	963*558*1350	894*718*1310
	Package size(W*D*H)(mm)	955*960*2100	970*1140*2190	1320*970*2190	1270*1105*2220
	CBM	1.93	2.42	2.8	3.12
	20GP/40GP/40HQ	12/24/24	12/24/24	2.80	8/18/18
Frozen Racks	Racks	16(5X4,4X4)	16(5X5)	8/18/18	24(5X5)
	Boxes (2 inches)	288	400	504	600
	Samples(2ml)	28800	40000	50400	60000
Alarm	High/low temperature	Y	Y	Y	Y
	Power failure	Y	Y	Y	Y
	Abnormal voltage	Y	Y	Y	Y
	Sensor error	Y	Y	Y	Y
	Filter screen check	Y	Y	Y	Y
	Thermostat failure	Y	Y	Y	Y
	Low battery	Y	Y	Y	Y
	Condenser clean	Y	Y	Y	Y
	High ambient temperature	Y	Y	Y	Y
	Door ajar	Y	Y	Y	Y
	Power failure backup system (alarm)	72h	72h	73h	72h
	CO2 back up system	Y	Y	Y	Y
	Accessories	Inside door	2	2	2
Test hole QTY/diameter		1/25MM	1/25MM	1/25MM	1/25MM
USB port		Y	Y	Y	Y
Chart recorder		/	/	/	/
Data logger		Optional	Optional	Optional	Optional
Remote alarm port		Y	Y	Y	Y
Optional	CO2 back up system	Optional	Optional	Optional	Optional
	LN2 back up system	Optional	Optional	Optional	Optional
Other	Certification	ISO,CE	ISO,CE	ISO,CE	ISO,CE



#Letsgivingore

Thanks to your purchase, a donation is made to a non-profit foundation that fights against cancer and helps vulnerable communities.



All rights reserved © KALSTEIN France S. A. S.,
2 Rue Jean Lantier • 75001 Paris •
+33 1 78 95 87 89 / +33 6 80 76 07 10 •
<https://kalstein.eu>
KALSTEIN FRANCE, S. A. S



-40 °C To -86° Ultra Low Freezer 728L Serie YR5304 (Dual System)

Energy-saving and environmental friendly



Max. safety for storage
Dual cooling system, double insurance

Advanced insulation tech
Fumed Silicon V.I.P & PURF

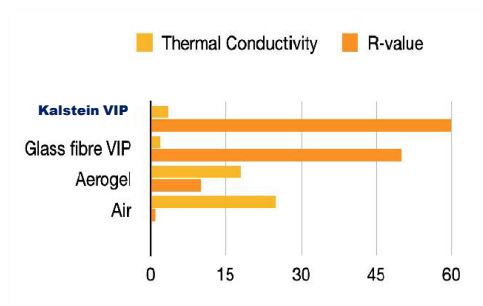
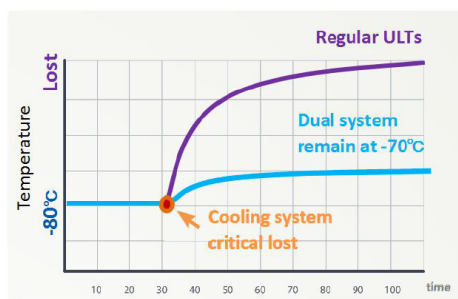

Kalstein Dual System

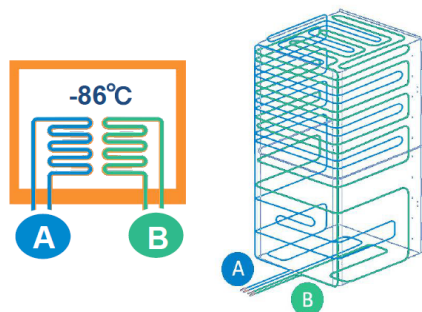

Extreme Safety

Dual system is designed with 2 independent cooling systems which provides extra insurance for Bio-samples. Should one system unexpectedly fail, the other will maintain a temperature in the -70°C range ensuring that the sensitive samples not put at risk separately.

Ultimate cooling performance

Dual cooling system maximizes optimal reliability, longevity and efficiency. Under normal working conditions, the 2 independent systems start in sequence at intervals. Then 2 systems work together to get a rapid pull-down performance.

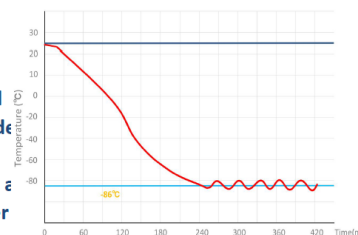

#Let'sgive more ♥
Thanks to your purchase, a donation is made to a non-profit foundation that fights against cancer and helps vulnerable communities.



All rights reserved © KALSTEIN France S. A. S.,
2 Rue Jean Lantier • 75001 Paris •
+33 1 78 95 87 89 / +33 6 80 76 07 10 •
<https://kalstein.eu>
KALSTEIN FRANCE, S. A. S



FEATURES



7" LCD touch screen
Easy operation and observation



Full information display
Alarms, curve, temperature and permission



10 types of alarm
Audible and visual alarms



Eco-friendly
CFC-free refrigerant and energy-saving

CONSTRUCTION

- 7" touch screen & USB port**
- Humanized Automatic pressure relief handle**
- Quick knock-down condenser filter**
- File box**
- White board**
- heavy duty castors**
- High precision**
- Detachable inner doors**
- Pressure-regulated**
- 5-layer silicone seals**
- Access port**
- PURF + SUS304 inner doors**

Accessories



Chart recorder



Racks & Boxes



LN2/CO2 backup system



Data logger



Antifreeze gloves



#Let'sgive more ♥
Thanks to your purchase, a donation is made to a non-profit foundation that fights against cancer and helps vulnerable communities.



All rights reserved © KALSTEIN France S. A. S.,
2 Rue Jean Lantier • 75001 Paris •
+33 1 78 95 87 89 / +33 6 80 76 07 10 •
<https://kalstein.eu>
KALSTEIN FRANCE, S.A. S





 **Kalstein**[®]
A different accompaniment, at your service

#LETSGIVEMORE 

**WITH THE
ACQUISITION
OF A KALSTEIN
EQUIPMENT**

YOU MAKE A CONTRIBUTION TO:

 **Fundación
Jacinto Convit**
<https://www.jacintoconvit.org/>

 **ONE
TREE
PLANTED**

<https://onetreepanted.org>

 **Humatem**
Solidarité et coopération
biomédicale
<https://www.humatem.org/>

 **MANIAPURE
FOUNDATION USA**
<https://www.maniapurefoundation.org/>

Articles Kalstein
(Social Networks and Official Websites)

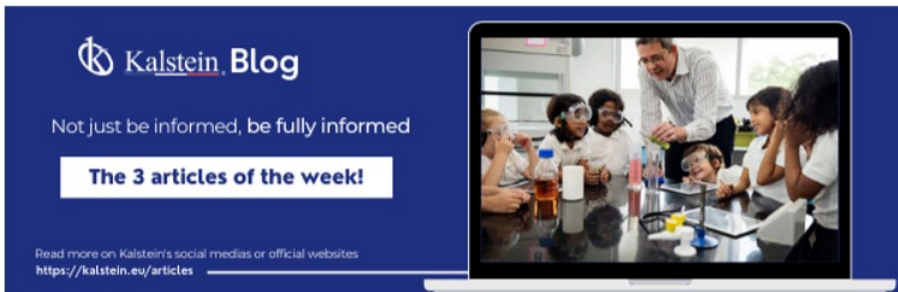

Kalstein Blog
Not just be informed, be fully informed

The 3 articles of the week!

Read more on Kalstein's social medias or official websites
<https://kalstein.eu/articles>



1
Read this ARTICLE NOW

How does the climate affect your microscope?

microscope is an instrument that allows observing and measuring objects that are too small to be seen with the naked eye. This is achieved through a complex system of lenses and mirrors, which form

Kalstein Blog

Article of the week:
How does the climate affect your microscope?

Read more on Kalstein's social medias or official websites
<https://kalstein.eu/articles>



2
Read this ARTICLE NOW

What is the importance of the laboratory refrigerator?

refrigerator is a device that is one of the most common pieces of equipment used in laboratories. It is a controlled environment (refrigerated space), various fluids and substances

Kalstein Blog

Article of the week:
What is the importance of the laboratory refrigerator?

Read more on Kalstein's social medias or official websites
<https://kalstein.eu/articles>

Kalstein Training Videos
(Youtube Channel and Official Websites)



Kalstein France - Jacinto Convit Foundation / Alliances

23 views • 3 years ago



Kalstein's Microscopes

445 views • 1 week ago



PARIS - FRANCE
HEADQUARTER
2 Rue Jean Lantier
75001 Paris - France

Tlf: +33 (0) 01 78 95 87 89
Cel: +33 (0) 6 80 76 07 10
sales@kalstein.eu

<https://kalstein.eu/>
<https://www.kalstein.fr/>

